

IP Based Lecturer Tracking and Board Writing Detecting System



LTC-A2001NV2



BLS-200

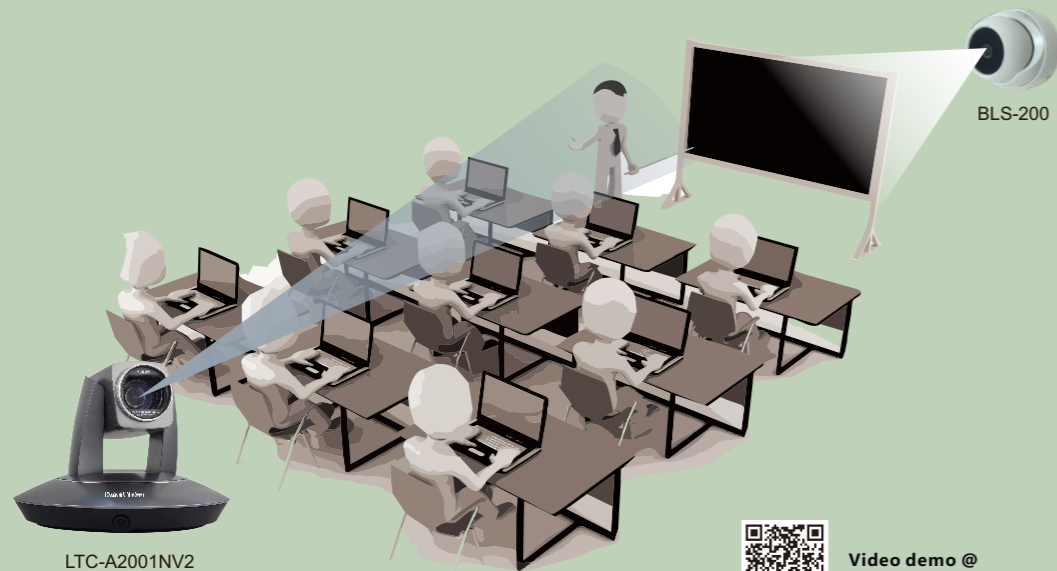

Video demo @
<http://youtu.be/FBgCnr8bW4>

This smart lecturer tracking and board writing detection system consists of an IP HD lecturer tracking camera and an IP board writing detecting camera (POE supported), configuration and installation of the system has never been so easy and effective; unique performance of the system is that, after the board writing detecting camera detects writing actions on the board, it triggers the lecturer tracking camera to automatically move to the pre-defined board position and start tracking lecturer there. If undetected, the lecturer tracking camera can either keep tracking lecturer or return to a pre-defined position and start tracking there.

Features



- **Board writing triggers tracking**

When board writing detecting sensor detects writing actions, it triggers the lecturer tracking camera to automatically move to pre-defined board position and start tracking lecturer there. If undetected, tracking camera can either stay or return to pre-defined position.

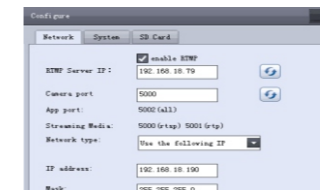

- **IP capability**

Both the lecturer tracking camera and board writing detecting camera support IP control and preview, optional POE. Free configuration software is provided together with device.



- **Unmanned and standalone tracking**

Tracking performance is realized by the system itself, both its two lens manage the tracking algorithm, there is no need to have manual operation or have extra devices / sensors to assist tracking.

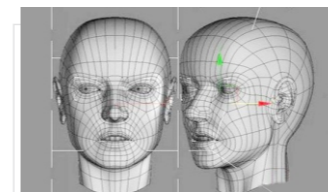

- **Precise lock and track capability**

Tracking is based on both face detection and motion detection technology, which ensures smooth and precise lock & track performance even in comprehensive scenarios.

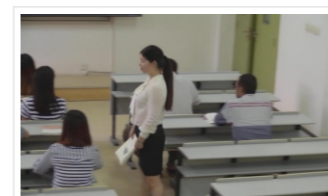

- **No “fish-eye” at full view lens**

The small full view lens of the tracking system addressed geometric distortion problem, it can be used as a standard image to shot lecturing area.

Technical Data

Model	LTC-A2001NV2
Tracking Camera	
Image Sensor	1/2.8" Exmor CMOS, 2.14MP
Lens	f=4.7mm - 94.0mm; F1.6 - F3.5
Zoom	Optical: 20X; Digital: 12X
Field of View	59.5° - 2.9°
Focus	Auto, Manual, One Push
Min. Illumination	0.5Lux
Shutter Speed	1/1 - 1/10,000s
Gain	Auto / Manual
White Balance	Auto, Indoor, Outdoor, One Push, Manual
Exposure	Auto, Manual, Shutter Pri, Iris Pri
S/N Ratio	≥50dB
Full View Camera	
Image Sensor	1/2.8" Exmor CMOS
Effective Pixel	2.14MP
White Balance	Auto
Exposure	Auto
Field of View	Horizontal: 72°; Vertical: 40°
Lens	3.4mm
PTZ	
Pan/Tilt Angle	Pan: -170° ~ +170°; Tilt: -30° ~ +90°
Pan/Tilt Speed	Pan: 0.1° ~ 120°/s; Tilt: 0.1° ~ 90°/s
Preset Number	256
Network	
Max. Image Size	1920 × 1080@60fps
Video Compression	H.264/H.265
Video Output	HD-SDI (2 Channels)
Video Format	1080P60, 1080P50, 1080P30, 1080P25, 1080i60, 1080i50, 720P60, 720P50
Network Protocol	ONVIF / HTTP / RTSP / RTMP / TCP / UDP
Simultaneous Users	Up to 10 users
Dual Stream	Support
Ethernet	RJ45, 100M
Comm. Interface	RS-485, RS-232
Protocol	VISCA, PELCO-D
General	
Power Supply	DC12V, optional POE
Power Consumption	< 20W
Working Temp	0°C ~ +40°C
Storage Temp	-20°C ~ +60°C
Dimension (L×W×H)	226mm x 212mm x 163mm
Weight	1.96kg
Color	Grey

Technical Data

Model	BLS-200
Image Sensor	1/3" Exmor CMOS
Effective Pixel	4.00MP
Min. Illumination	1Lux@F2.0
S/N Ratio	≥50dB
Gain	Auto
Shutter Speed	1/30 - 1/10,000s
White Balance	Auto
Focal	2.4mm
View Angle	90°(Wide), 50°(Tele)
Aperture	F2.0
Video Compression	H.264
Kbps	32Kbps - 8Mbps
Video Frame Rate	720p30, 1080p30
Ethernet	10-100M, Support POE
Power Supply	DC12V, POE
Power Consumption	< 5W
Working Temp	0°C ~ +40°C
Humidity	≤90% (No Condensation)
Dimension (L×W×H)	φ93mm x 81mm
Weight	0.33kg

Dimensions

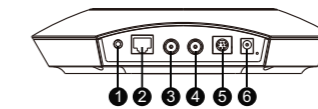
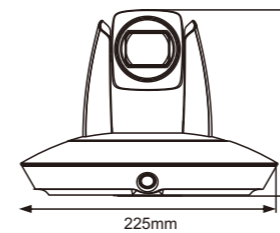

- 1 Audio
- 2 Ethernet
- 3 HD-SDI 1
- 4 HD-SDI 2
- 5 RS-485 / RS-232
- 6 DC12V
- 7 Regulating ring
- 8 DC12V
- 9 POE

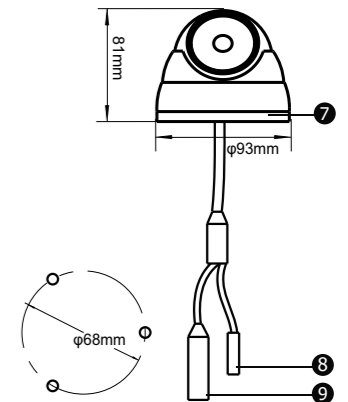

Accessories

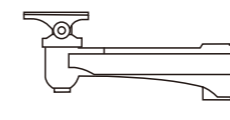

Wall Bracket

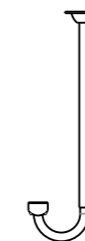

Ceiling Mount Bracket